

UNIVERSAL ACCESORIES SET FOR CALIPER

- Patent UA135339
- Universal accessories set for calipers **NEW**
- Fixator set with 2-4 sets
- Anvils can be installed in any positions **NEW**
- Modifications for different types of calipers

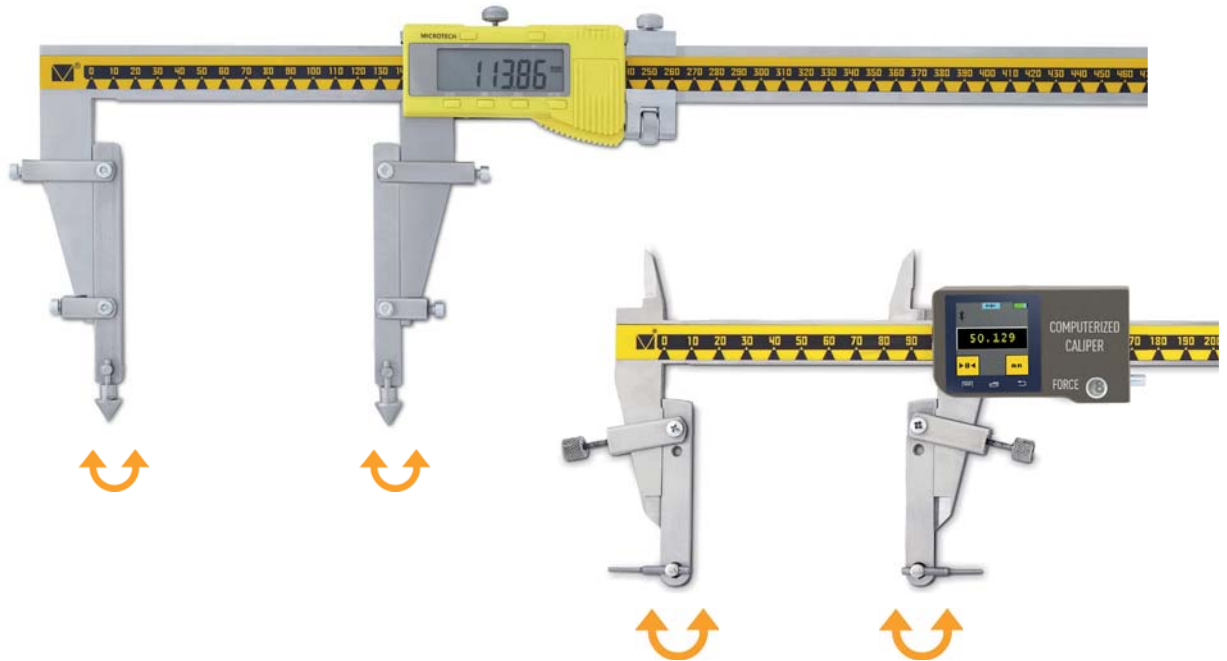

Item No	Compatible caliper ranges	Fixator set	D 2mm pin set	D 3mm scriber set	D 12mm cone set	D 12mm flat set
	mm		carbide	carbide	steel	steel
140010001	0-150 0-200 0-300	+	+	+		
141010005	0-150 0-200 0-300	+	+	+	+	+
140030001	0-500 Jaw 100mm	+	+	+		
141030005	0-500 Jaw 100mm	+	+	+	+	+
140031001	0-500 Jaw 150mm	+	+	+		
141031005	0-500 Jaw 150mm	+	+	+	+	+
140032001	0-1000 Jaw 150mm	+	+	+		
141032005	0-1000 Jaw 150mm	+	+	+	+	+

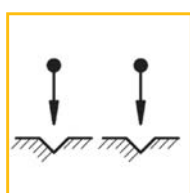
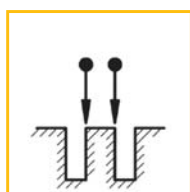
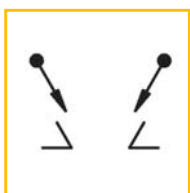
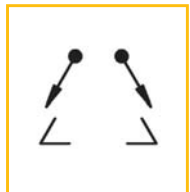
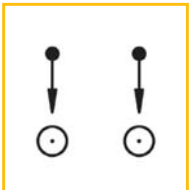
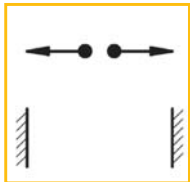
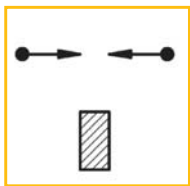